

Desktop Health

3D-BIOPLOTTER

The trusted bioprinting solution — from R&D
to regulatory-approved manufacturing

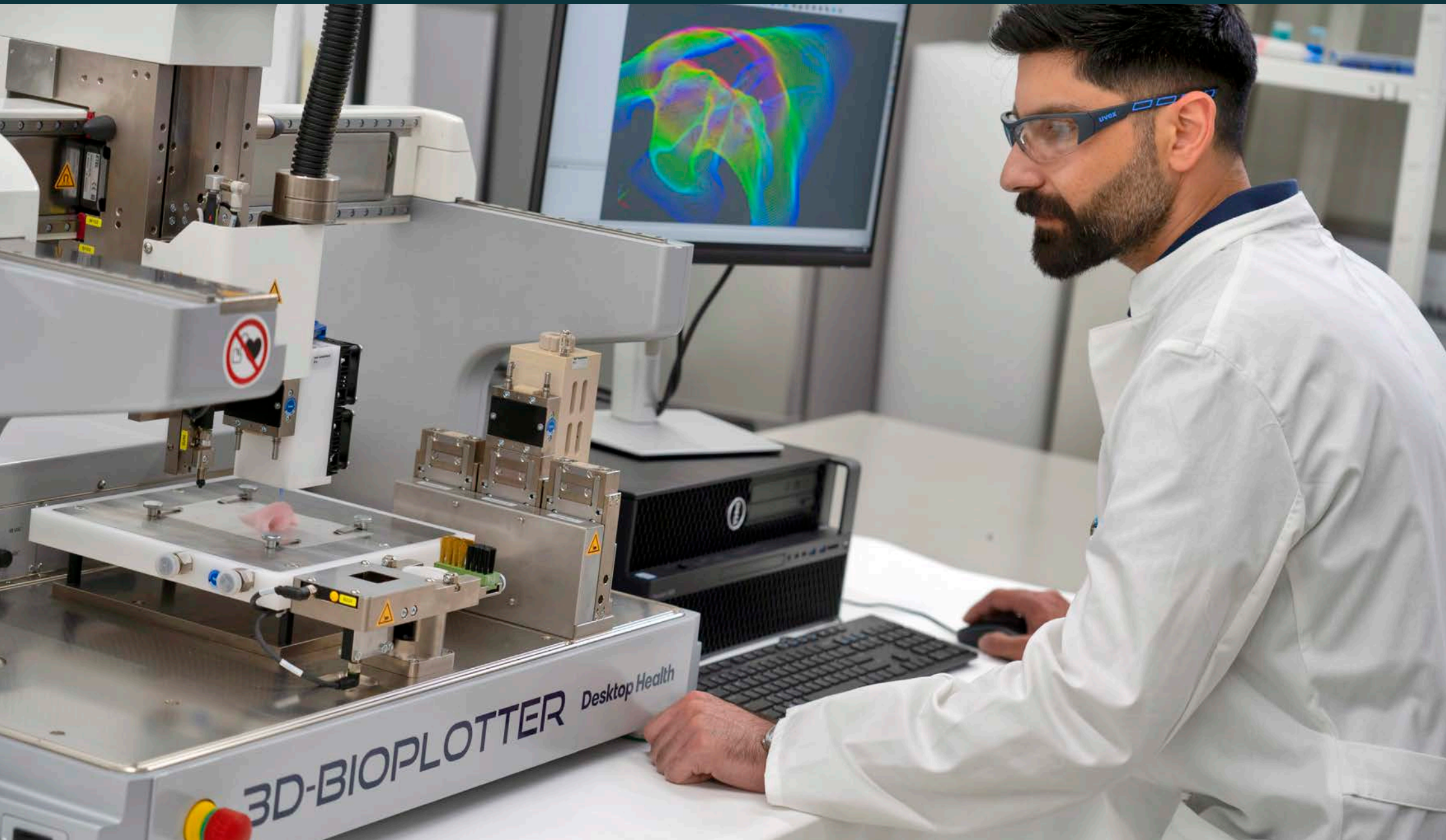

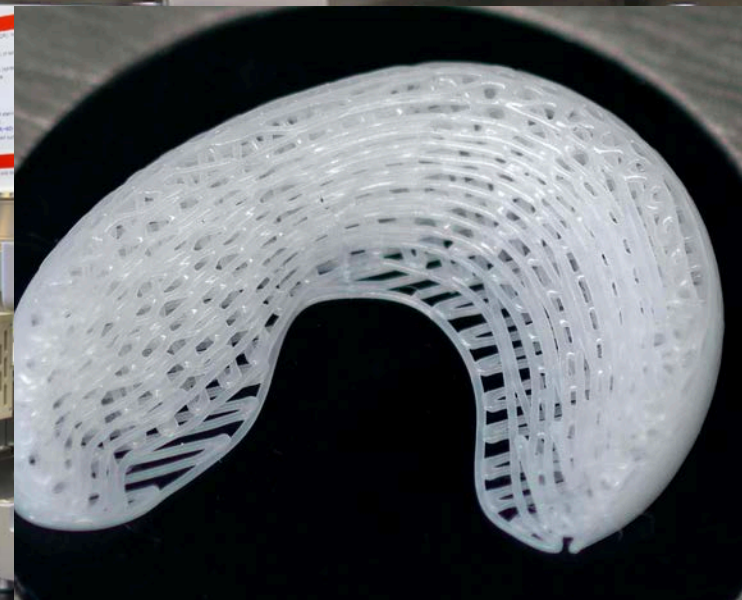
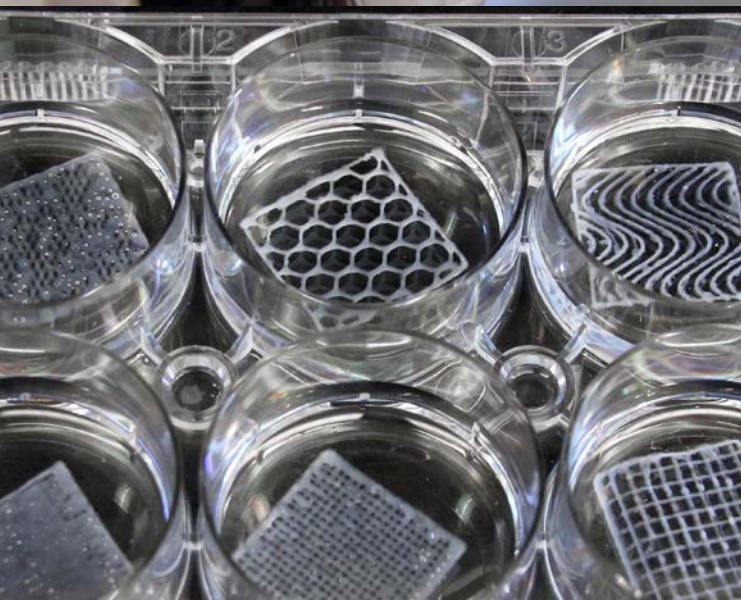
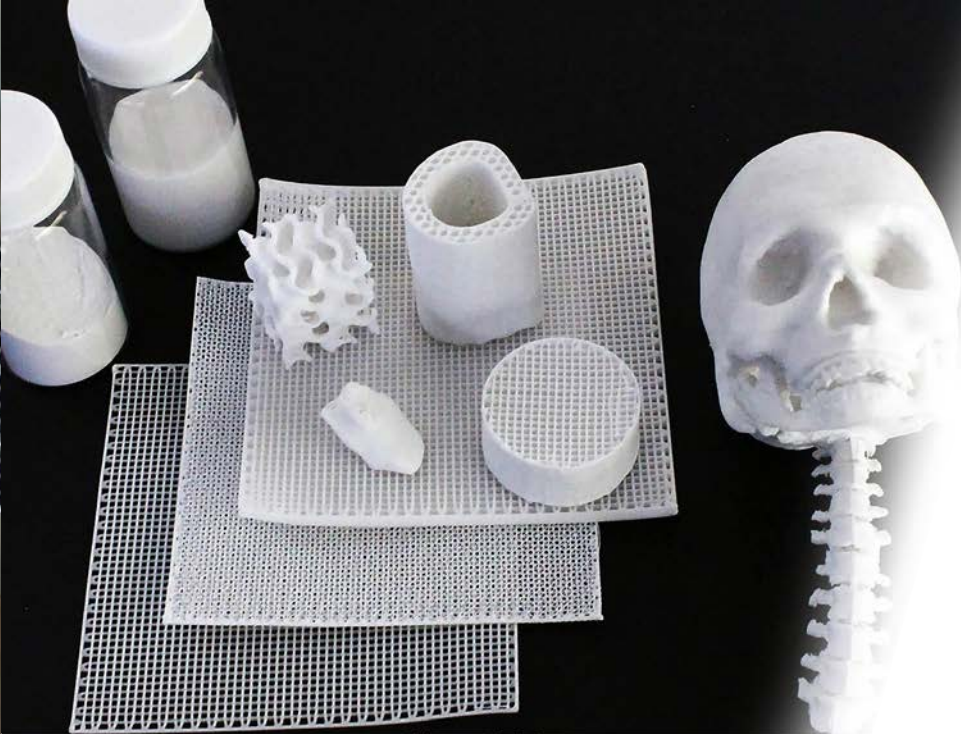

Table of Contents

History of the 3D-Bioplotter	4
Our Bioprinting Process	6
3D-Bioplotter Overview	8
Comparing Configurations	10
Manufacturer Series	12
Developer Series	14
Printheads	16
Materials	18
Accessories & Upgrades	20
Applications & Use Cases	22
FDA 510(k)-Cleared: CMFlex™	24
About Desktop Health™	26
PhonoGraft® Hearing Restoration	28



TOP LEFT, FACING PAGE: Ramille Shah, Co-Founder and Chief Scientific Officer with Chicago-based Dimension Inx uses the 3D-Bioplotter to produce CMFlex™ the first 3D-printed regenerative bone graft product to receive 510(k) clearance from the U.S. Food and Drug Administration (FDA).

BOTTOM LEFT: These varied hydrogel prints demonstrate different design patterns available on the 3D-Bioplotter software, with different patterns delivering different mechanical and biological properties.

BOTTOM CENTER: The New Jersey Center of Biomaterials uses the 3D-Bioplotter to develop and 3D print tissue scaffolding to help the body regenerate functional organs. Shown here with Joseph Steel, PhD, formerly of the center and now a principal scientist with a global health and nutrition company.

BOTTOM CENTER RIGHT: A knee meniscus 3D printed in flexible Polycaprolactone (PCL) aimed at providing sufficient mechanical support during the patient's cartilage regeneration process.

BOTTOM RIGHT: Columbia University uses the 3D-Bioplotter to unlock possibilities in tissue engineering and regenerative medicine. Shown here with Solaimain Tarafader, a former Research Scientist at Columbia University and now with a private research foundation.

COVER: The 3D-Bioplotter Developer Series is used by Dalsouz Ismaeel, a team lead Lab at Desktop Health to fabricate a hydrogel prosthetic nose as shown in the digital file displayed on the monitor.

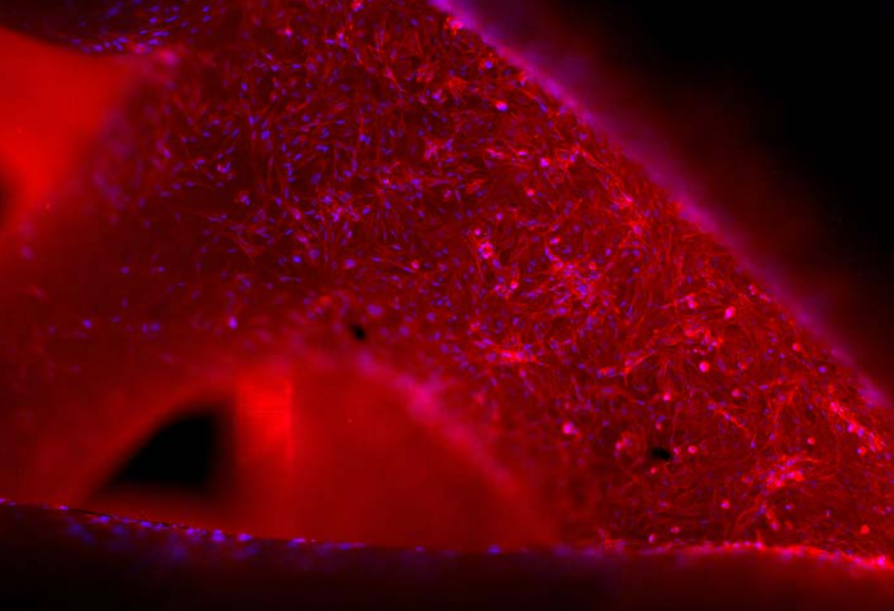

Left, Stem cells growing on the surface of strands of a Tissuelink® scaffold printed on the 3D-Bioplotter. Image provided by NanotecMARIN GmbH

A History of Reliable Innovation

When medical researchers and manufacturers talk about “The Bioplotter,” this is the printer they’re talking about

The Desktop Health 3D-Bioplotter is the world’s original bioprinting system¹. Developed in Germany at the University of Freiburg and launched in 2000, the 3D-Bioplotter is a state-of-the-art, extrusion-based printing system that has been unmatched in the marketplace for more than two decades.

A breakthrough product then and now, the 3D-Bioplotter has benefited from continuous upgrades based on the feedback and partnership we have with our world-class users. Recent developments include our new PrintRoll™ build platform and our two-in-one UV print-and-cure printhead, which brings our total number of modular printheads offered for use on the system to eight, each with its own functionality.

In all, the 3D-Bioplotter has been cited in more than 2,490 research papers, with more than 600 peer-reviewed research papers² published based on research done with the 3D-Bioplotter across a wide range of categories – from soft tissue and organ printing to bone regeneration and drug release to 4D applications, in which a 3D printed object transforms itself into another structure or is degraded over time.

Today, a variety of medical devices and products are researched and developed on the 3D-Bioplotter, with some of the first applications now being cleared by regulators, such as CMFlex™, an easy-to-use flexible bone graft product, with many more on the pathway to commercialization, such as the PhonoGraft® biomimetic eardrum restoration device. Both products are discussed later in this brochure.

So, why is the 3D-Bioplotter such a phenomenon in the world of bioprinting? The 3D-Bioplotter is a highly sophisticated extrusion-based printer that processes liquids, melts, pastes, gels, or other materials, including cells, through a needle tip on a Swiss-made, 3-axis gantry system. Objects can be fabricated on the sturdy, vibration-free platform – more than 90 kg or about 200 lbs – with high precision and repeatability.

Materials are managed in this open system with an easy-to-use syringe-cartridge system paired with a variety of needle tip sizes from 0.1 mm to 1.2 mm. Air pressure is applied to the syringe, which deposits a strand of material through the needle tip for the length of movement and time the pressure is applied. Parallel strands are plotted in one layer. For the following layer, the direction of the strands is turned over the center of the object, creating a fine mesh with good mechanical properties and well-defined porosity.

One of the most appreciated features of the system is the full control it gives users in virtually every area of the process – including temperature, pressure, speed, and design – through an intuitive software system. Other features appreciated by our users include built-in sterility controls and a range of time-saving features, such as an automated printhead changer, a clean and calibration station, and a database of inner patterns, including functionality for easy complex shape creation.

As one of the world’s most sophisticated extrusion systems, the 3D-Bioplotter is also used for non-medical purposes as well, including 3D printing of metals and foods.

1. <https://www.ncbi.nlm.nih.gov/pmc/articles/PMC7610207/> 2. <https://TeamDM.com/DH3DBioplotter>

Two Decades of 3D-Biplotter Innovation

Breakthrough technology and research papers with the industry-leading bioprinter



2000+

2000 | 1st paper published on 3D-Biplotter prototype from Universität Freiburg

2002 | 1st paper published on scaffold/cell interaction

2002 | 1st Gen 3D-Biplotter from EnvisionTEC installed

2004 | 2nd Gen 3D-Biplotter introduced

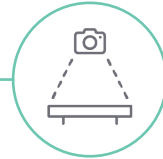

2005+

2006 | 3rd Gen 3D-Biplotter introduced

2008 | 1st paper published on printing cell suspensions (bioprinting)

2009 | 4th Gen Manufacturer Series introduced as the first bio printer for both academic and commercial use, including a high-definition camera for medical traceability



2010+

2010 | 1st paper published on drug-releasing applications

2012 | 1st paper published on printing electrical conductive materials

2013 | Developer Series introduced to make tissue engineering research and development more accessible



2015+

2016 | 1st paper published on 3D printed Hyperplastic Bone® graft

2017 | 1st paper published on bioprosthetic printed ovary (functional organ printing)

2019 | 3D-Biplotter releases design upgrades with larger build areas and introduction of Co-Axial, Inkjet, and Multiwavelength printheads

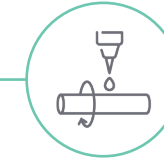

2020+

2020 | Release of Print and Cure printhead (385nm and 405nm wavelengths)

2022 | 1st FDA 510(k) cleared bone regeneration product (CMFlex™) from Dimension Inx

2023 | Launch of PrintRoll™ a rolling build platform to print patterned cylindrical tissue scaffolds



3D-Biplotter Applications

- Bone Regeneration
- Controlled Drug Release
- Soft Tissue Fabrication
- Cartilage Regeneration
- Cell Printing
- Organ Printing
- 4D Printing
- Other Precision Extrusion Applications

Left, the 3D-Biplotter Manufacturer Series manufactures the PhonoGraft device en masse. The device is currently on a pathway to pursue FDA 510(k) clearance and commercialization.

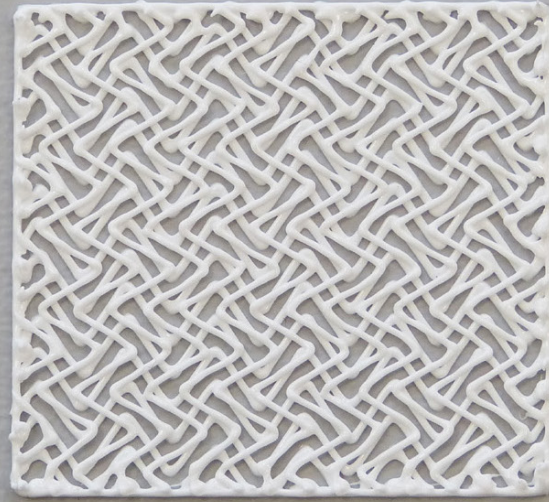
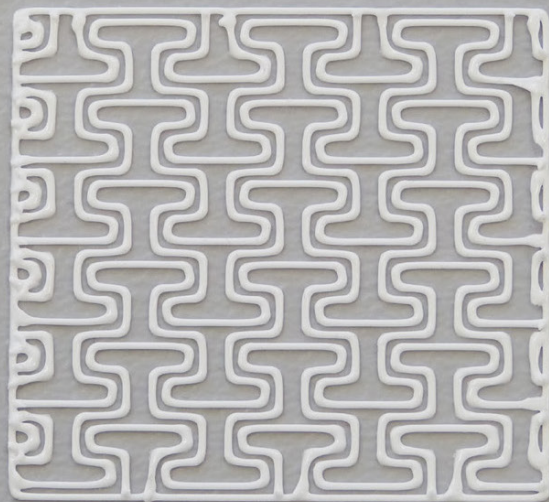
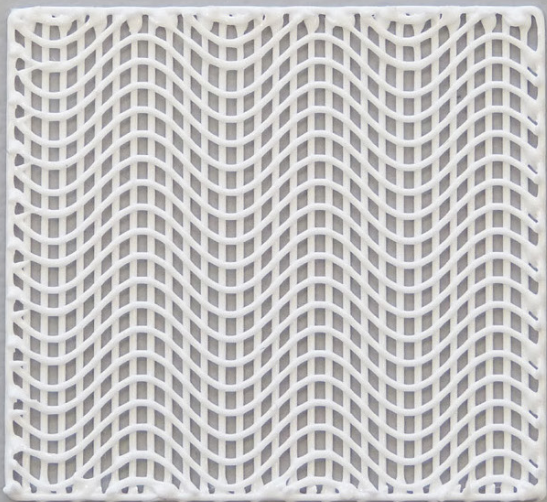
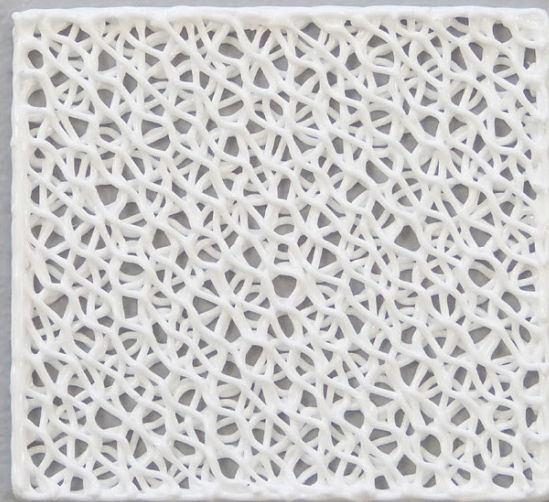
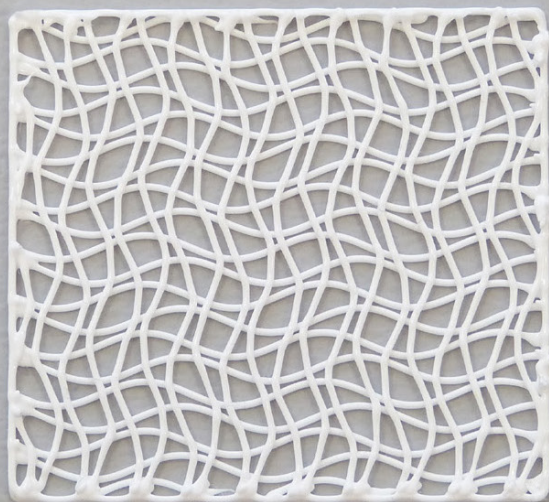
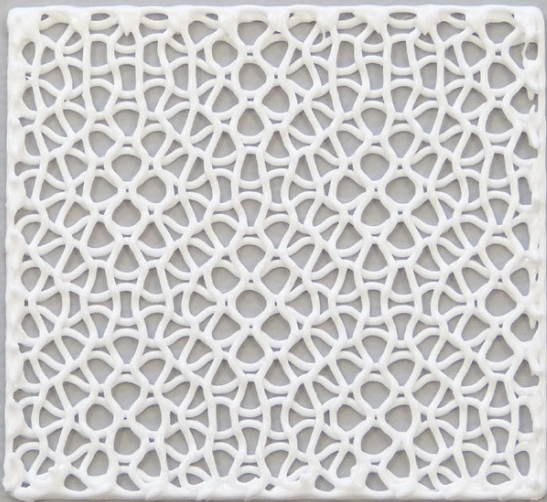
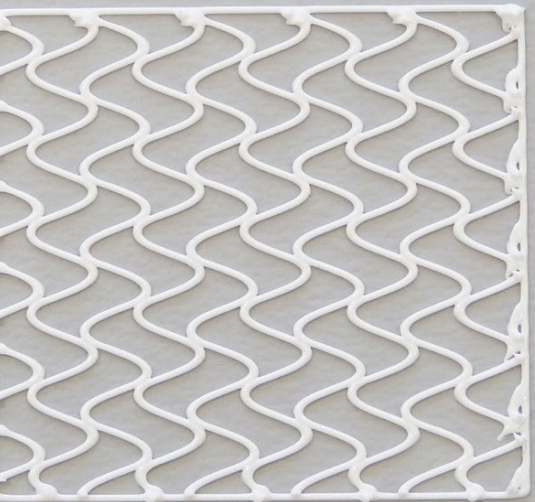
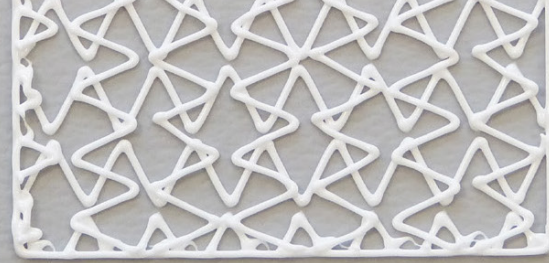
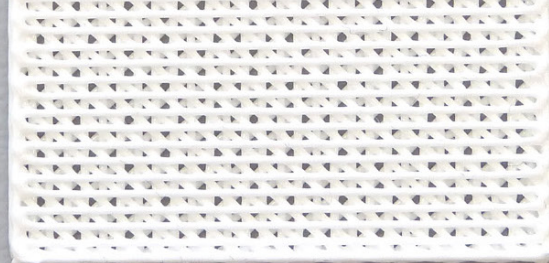
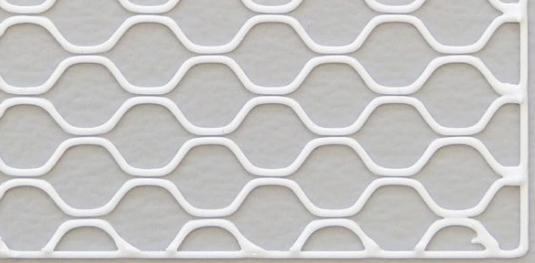

Our Bioprinting Process

A simple extrusion process with extremely tight software control of thermal and mechanical settings enables new possibilities. A wide range of materials can be extruded or plotted from 2°C to 500°C (35.6°F to 932°F) into a medium on the build plate ranging in temperature from -10°C to 80°C (14°F to 176°F).

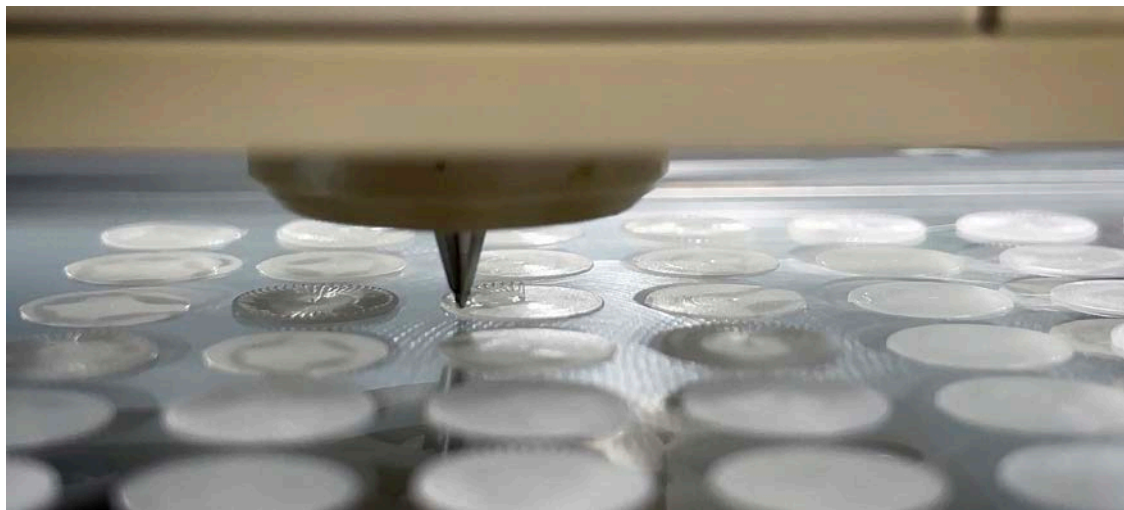

1 Select Print Material

Fill the selected liquid, paste, gel, or granulate to be printed into the cartridge with Luer Lock needle tip, attach an air pressure adapter, and place it into the corresponding printing head.

2 Control Printing Conditions

Use the provided software to select which printhead you'll be printing with, which will engage temperature monitoring and control. If required, activate the heating and cooling process for the printhead and platform.

3 Prepare the Print Project

Select the part to be printed and assign material printing parameters and pattern designs from the user-editable databases as necessary.

4 Start Printing!

Place the substrate (film, petri dish, or well plate) on the platform. Calibrate needle tip position and start the print job.

OVERVIEW

The 3D-Bioplotter Platform

The base platform of the 3D-Bioplotter is robust, highly modular for easy operation and upgrades, controlled by user-friendly software, and designed with sterility in mind

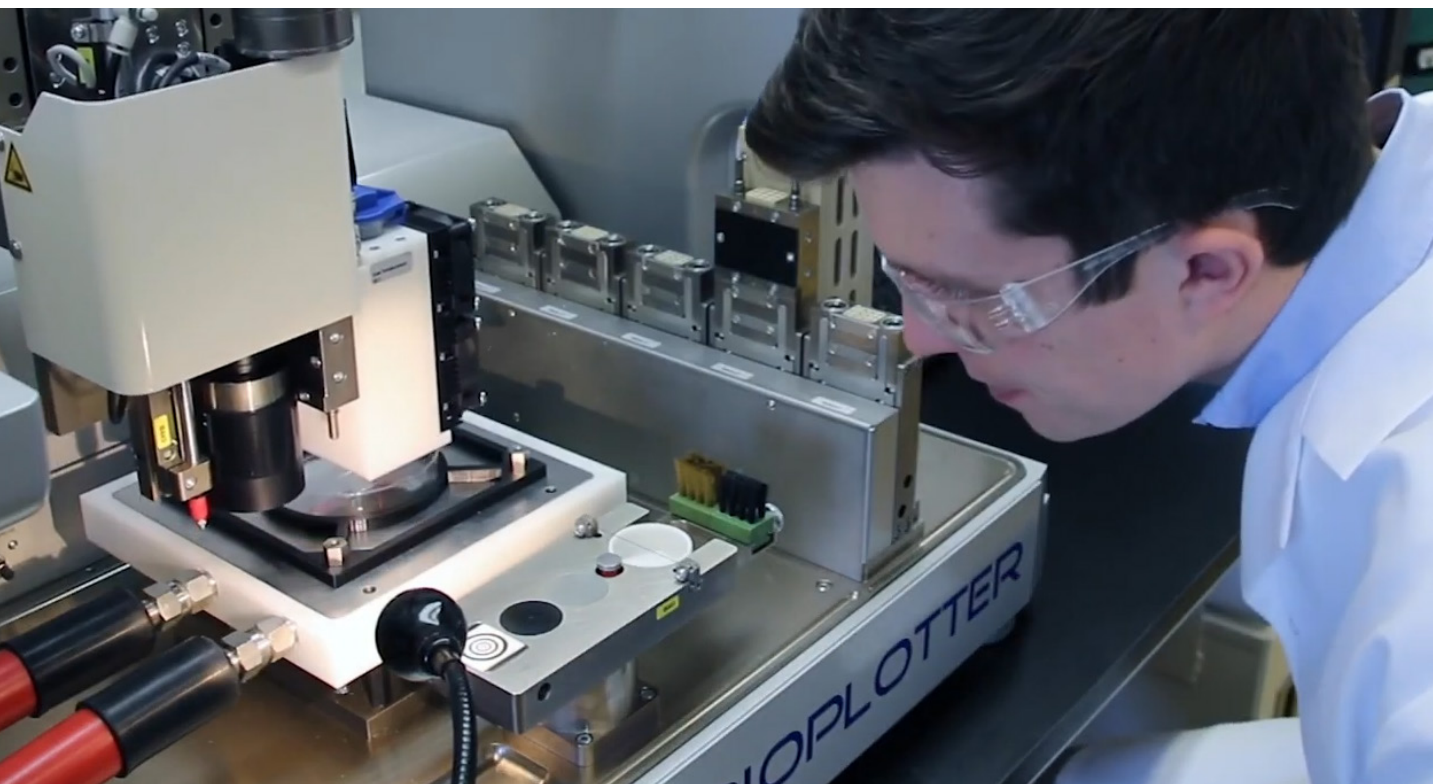

SYSTEM HIGHLIGHTS



High-precision, Swiss-made 3-axis extrusion 3D printing system that uses pneumatic pressure to dispense a wide range of materials



Vibration-free robust machine frame designed for durability and stability during continuous use



Modular design enables ease of use and easy upgrades. Add new features to existing machines easily, like new printheads or other accessories



Included software enables high level of control, with automated, time-saving features and quality management



Automatic tool changer for multiple printheads enables serial production of multiple parts and materials



Printheads work with standard Luer Lock needle tips, 0.1mm to 1.2mm inner diameter available



Open material system — no pre-processed filament required. Medical grade, as well as cell-laden, materials can be used. Users can also choose their preferred vendors, as well as their own medical grades, mixture compositions, concentrations, and additives

HARDWARE



OVERALL

- Footprint (L x W x H): 976 x 623 x 773 mm (38.4" x 24.5" x 30.4")

- Weight: 90-130 kg (depending on the model)
- Electrical Requirements: 100-240 VAC, 50/60 Hz
- Compressed Air Requirement: 6 - 10 bar (85 - 145 psi)



STERILITY

- Designed for use in a sterile environment within a biosafety cabinet
- Built-in particle and sterile filters for compressed air
- Sterilizable cartridges for material storage, thus avoiding touching the machine
- Designed for easy cleaning and sterilizing



PRINTING SYSTEM

- Three printhead stations included on Developer Series. **Five stations included on Manufacturer Series**
- Two printheads come standard with system, upgrade to fill all stations. Eight modular printhead options offered



TEMPERATURE

- Individual temperature control of each printhead, both in the parked and printing positions
- **Temperature control of build plate standard on Manufacturer Series.** Optional on Developer Series



AUTOMATION

- Automatic substrate height detection for petri dishes, well plates, as well as other printing surfaces
- Automatic needle tip cleaning, before and during printing
- Automatic recalibration of critical hardware settings in the background during regular use

MEDICAL-GRADE TRACEABILITY



- **Built-in high definition camera for data logs and high-accuracy calibration, parameter tuning, and mid-print measurement of strand dimensions – Manufacturer Series only**

SUPPORT



- Remote Support software included to ensure fast response anywhere worldwide

SOFTWARE



COMPLETE CONTROL

- All printing parameters, including temperature, pressure, speed, and more, are software-managed
- Temperature curves with up to five set points and waiting times are available



MATERIAL MANAGEMENT

- User-editable database of materials, with all process parameters (temperature, pressure, speed, etc.)
- Material lifetime controls to avoid scaffold fabrication with degraded materials

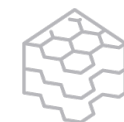

COMPLEX PART SUPPORT

- User-editable database of inner patterns – a time-saving feature that eliminates need to design patterns in the STL and 3MF files
- A wide variety of inner patterns included, such as straight lines, zig-zag shapes, and wave forms, as well as hexagon shapes, including shift functions for “in between the lines” printing or hybrid scaffolds
- Input of outer shapes through

- STL or 3MF files, independent of the source (CAD, CT scanner, etc.)
- Simple automated generation of volume supports for complex shapes



QUALITY CONTROL

- Improved surface finish of fabricated parts using randomized start positions in outer contours
- Multiple contour control for reinforcement of outer structures and mechanical properties



MEDICAL-GRADE TRACEABILITY

- Log file creation after project completion with all relevant data
- **Photographic log of the full object for each layer available for verification of error-free object interior after printing— Manufacturer Series only**



USER MANAGEMENT

- A User Management System allows individual users to both share projects, materials, and patterns, as well as have their own separate set of settings for improved overview and security

Comparing Configurations

The 3D-Bioplotter comes in two configurations — our state-of-the-art **Manufacturer Series** and a more affordable (but still highly capable) **Developer Series**



Developer Series for Research & Development

Designed as an affordable, still highly capable bioprinter for research groups new to bioprinting. Consists of the same core hardware and software as the Manufacturer Series, but with reduced functionality. Not upgradable to the same capability of the Manufacturer Series.



Manufacturer Series for Commercialization

Designed as a tool for both advanced research, as well as commercial production. Capable of using all hardware and software options of the 3D-Bioplotter Series. Key differences include accuracy delivery, camera, and build plate temperature controls.

3D-Bioplotter System Configurations — Highlights

	Developer Series	Manufacturer Series
Footprint (L x W x H)	976 x 623 x 773 mm (38.4 x 24.5 x 30.4 in)	976 x 623 x 773 mm (38.4 x 24.5 x 30.4 in)
Max build envelope (L x W x H)	200 x 220 x 140 mm (7.87 x 8.66 x 5.51 in)	200 x 220 x 140 mm (7.87 x 8.66 x 5.51 in)
Temperature-controlled build platform — heated and cooled; -10 °C to 80 °C (14 °F to 176 °F)	Optional feature	Standard feature
Needle tip calibration accuracy (XY)	30 µm	9 µm
Needle tip calibration accuracy (Z)	30 µm	1 µm
High-resolution camera for recording logs	Not offered	Standard
Method of calibration	Automated with light sensor for XYZ	Automated with on board camera for XY; Needle tip pressure sensor for Z
Modular printhead stations	3 available	5 available
Module printhead availability	2 come standard with system, 8 available	2 come standard with system, 8 available
Filters, particle and sterile	Standard	Standard
Industrial PC with automatic hard drive backup system	Standard	Standard
Temperature curves	5 points	5 points
Substrate height sensor	Standard	Standard

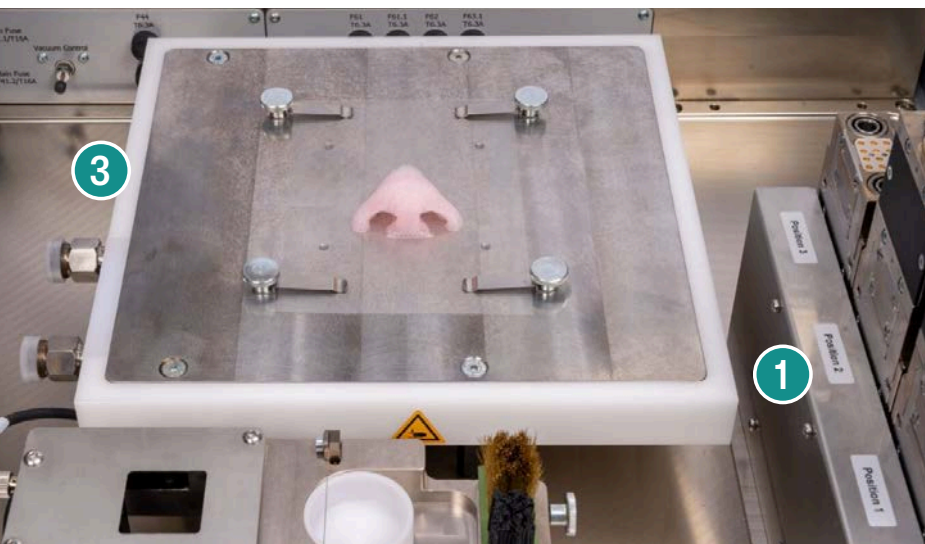
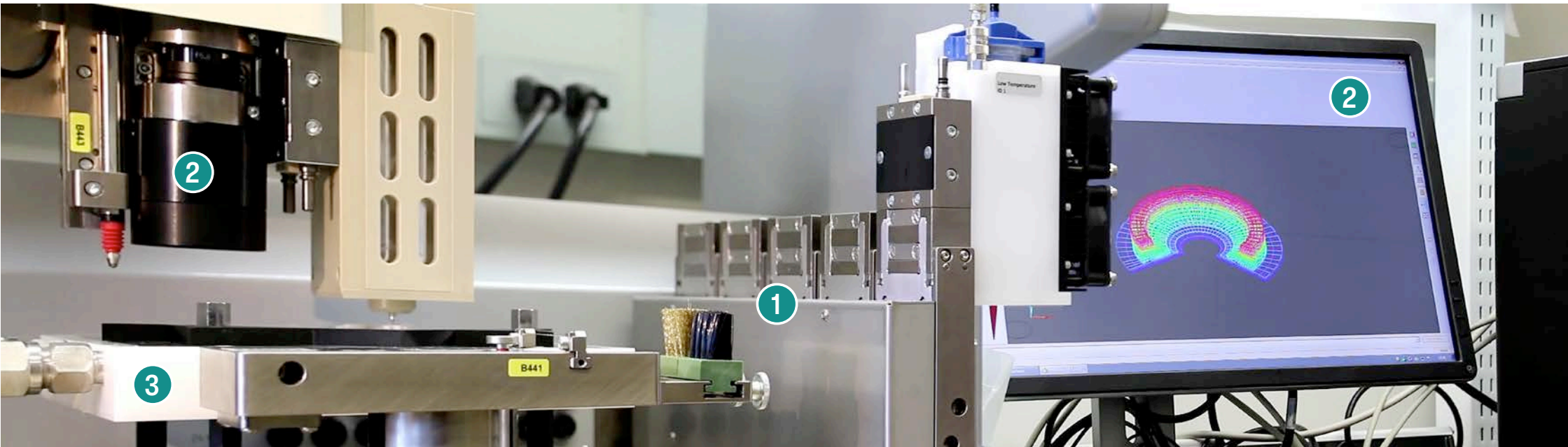

Functional Differences in Model Configurations

A few of the key differences between the Manufacturer and Developer configurations are shown and annotated here.

1. While the Manufacturer Series, shown above, has five (5) stations for modular printheads, the Developer Series, shown left, has three (3).
2. The Manufacturer Series' high-resolution camera, for calibration and quality management, is a key differentiator. Shown right, the camera captures images of parts during the build process that are logged in the software, shown above.
3. The build plate on the Developer Series can be upgraded for the same temperature controls offered on the Manufacturer Series.

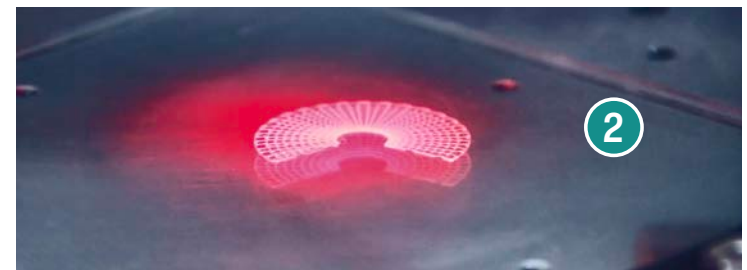

Manufacturer Series

This state-of-the-art tool is designed for high precision and reliable repeatability — with traceability tools built in for quality and regulatory management

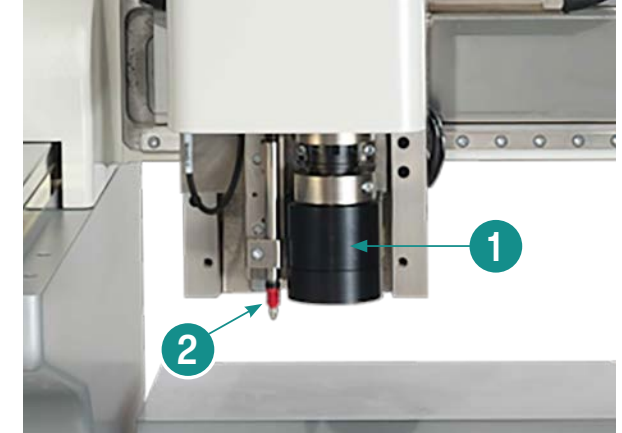

DETAILED VIEW

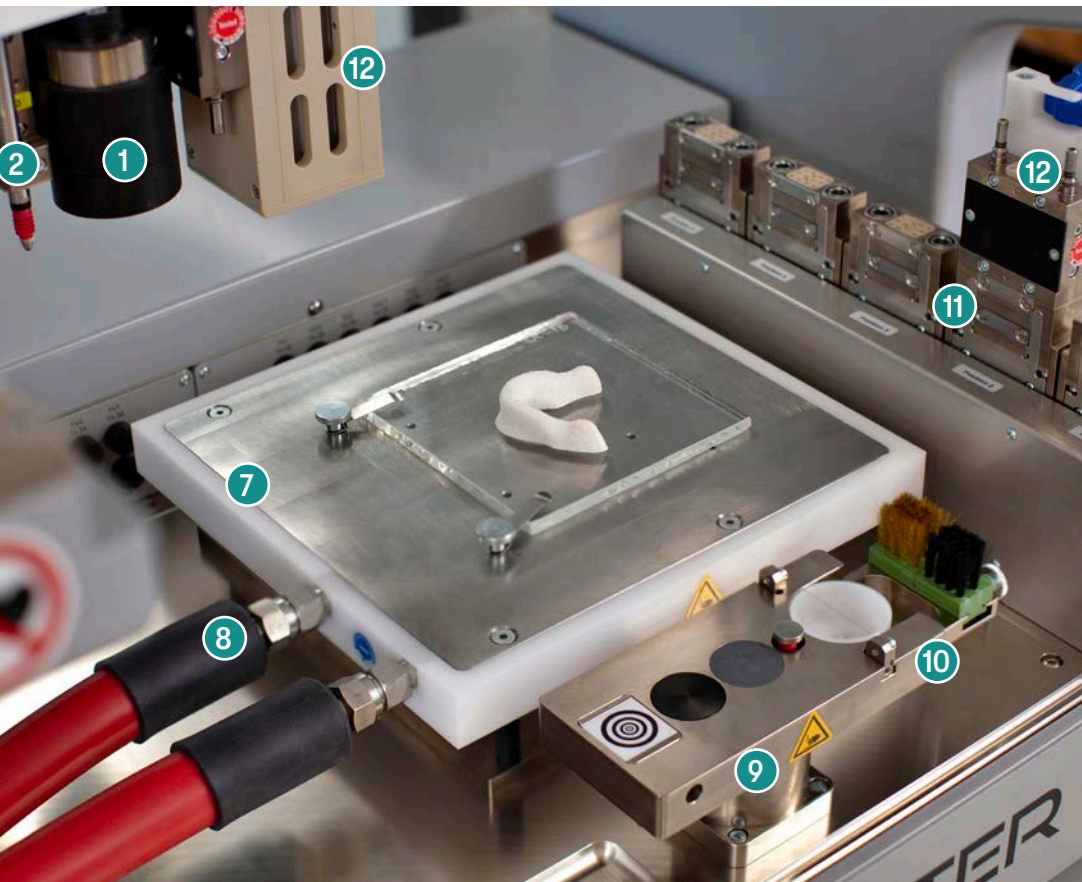

1. **High-Definition Camera** — for calibration of the needle tip in X and Y, strand diameter control with 9 μm resolution, and photographic logs for quality control and regulatory filing
2. **Platform Height Sensor** — a touch sensor detects the height of the Petri dish, well plate or other chosen platform substrate at job start. Enables position accuracy of 1 μm
3. **Particle Filter** — captures particulates from the compressed air line, such as accumulated water, oil or dust
4. **Sterile Filter** — ensures sterility of the output from the compressed air line
5. **Network Connection** — ethernet ports for "machine" and "upper camera" to connect to PC, as well as temperature sensors, communicate with software
6. **Fuses** — easily accessible on the front of the system, these safeguard the complete electrical systems
7. **Temperature-Controlled Build Platform** — offering XYZ build space of 200 x 220 x 140 mm (7.87" x 8.66" x 5.51"), this heatable and coolable platform delivers a temp range from -10°C to 80°C (14°F to 176°F). Also features frames to hold well plates, Petri dishes, and microscope slides
8. **Minichiller Inlet and Outlet**
9. **Calibration Station** — the left side of this platform features two easy to clean circular surfaces to calibrate the needle tip with an accuracy down to 9 μm in X and Y, and 1 μm in Z
10. **Cleaning Station** — the right side of this platform features a metal wire to purge excess material from the needle tip into a removable basin, and a metal and plastic brush to clean the needle tip
11. **Tool Changing System** — this advanced system comes with five (5) printhead stations and can automatically change printheads throughout the print job, as programmed. This system also continuously monitors and controls individual printhead temperatures
12. **Modular Printheads** — this system comes with two standard printheads, a low-temp as well as a high-temp printhead. A range of other printhead types are also available for purchase
13. **High-Precision Motion Control System** — these Swiss-made axes with linear motors deliver 1 μm position accuracy
14. **Emergency Stop Button**
15. **Power On/Off Switch**



Developer Series

This highly capable system for research and development offers new functionality with the PrintRoll™ and can be upgraded in key areas



The new PrintRoll™ rotating build plate, shown above, is available for use on both the Developer and Manufacturer Series models. The modular build plate and printhead system allows for easy functional upgrades of the platform.

DETAILED VIEW

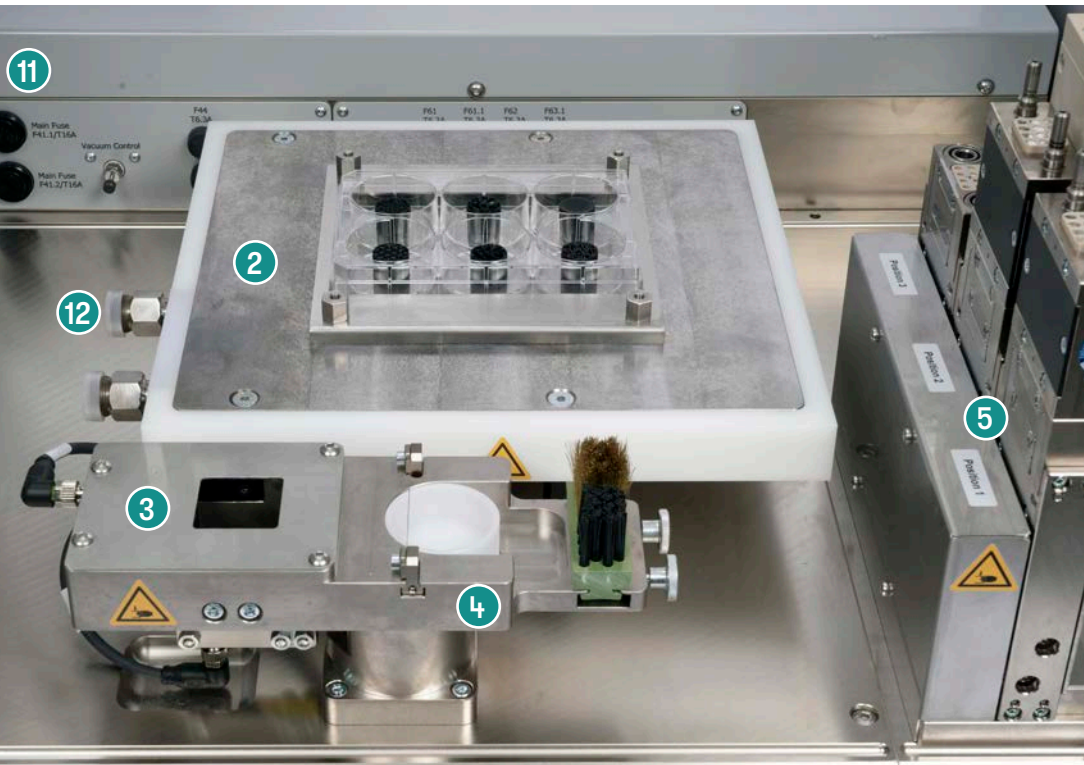

1. **Platform Height Sensor** – attached to the dispensing head mount, the sensor calculates the height of the chosen Petri dish or other build plate surface. Enables printing on substrates with 1 μ m accuracy
2. **An Upgradable Build Platform** – offering XYZ build space of 200 x 220 x 140 mm (7.87" x 8.66" x 5.51"), this standard build platform features frames to hold well plates, Petri dishes, and microscope slides. It can be upgraded for the same -10°C to 80°C (14°F to 176°F) heating and cooling capabilities offered on the Manufacturer Series
3. **Calibration Station** – the left side of this platform features a set of two light sensors to calibrate the position of common needle tips in XYZ in a non-contact process. Needle tip accuracy on the Developer Series is 30 μ m
4. **Cleaning Station** – the right side of this platform features a metal wire to purge excess material from the needle tip into a removable basin, and a metal and plastic brush to clean the needle tip
5. **Tool Changing System** – this advanced system comes with three (3) printhead stations and can automatically change printheads throughout the print job, as programmed. This system also continuously monitors and controls individual printhead temperature as well as temperature monitoring
6. **Modular Printheads** – this system comes with two standard printheads, a low-temp as well as a high-temp printhead. A range of other modular printheads and upgrades available for purchase, including PrintRoll™
7. **High-Precision Motion Control System** – these Swiss-made axes with linear motors deliver 1 μ m position accuracy
8. **Particle Filter** – captures particulates from the compressed air line such as water or oil that may have accumulated
9. **Sterile Filter** – ensures sterility of output from compressed air line
10. **Network Connection** – ethernet port to connect to PC
11. **Fuses** – easily accessible on the front of the system, these are the fuses for the complete electrical systems
12. **Upgradable for Cooling Capabilities**
13. **Power On/Off Switch**
14. **Emergency Stop Button**



Printheads

Our modular printhead system enables the widest range of printing temperatures in bioprinting, as well as easy functional upgrades, regardless of model

With eight (8) modular printheads, users will find every functionality they need to pursue R&D or commercial production of bioprinting solutions on the 3D-Bioplotter.

With our highly modular approach, newly developed printheads can be purchased years after the initial purchase of the 3D-Bioplotter, increasing the functionality of the machine without having to purchase a completely new system.

Users can also change the functional

configuration of their printer with different printhead combinations. Automation also makes multi-material printing easy, as the 3D-Bioplotter software drives pick-up and swap-out of printheads according to project settings.

Cleaning printhead needle tips during a print job is also easy with software programs that drive needle tips through a routine that includes brushing off excess material with a plastic and metal brush.



Print and Cure Printhead

Temperature control: 2°C – 70°C (dependent on room temperature, 0°C may be reached)

Materials: Light curable hydrogels, pastes, silicones, etc.

Wavelengths: 365, 405nm

Brightness per wavelength: ~65mW/cm²

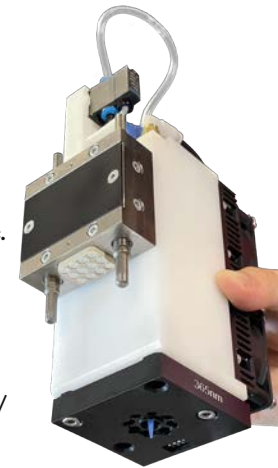

Low-Temperature (LT) Printhead

Temperature control: 2°C – 70°C (dependent on room temperature, 0°C may be reached)

Materials: Hydrogels, ceramic and metal pastes, mixtures with organic solvents, silicones, etc.



Standard syringes and Luer Lock needle tips are easy to drop in and print



High-Temperature (HT) Printhead

Temperature control:
30°C – 250°C

Materials:
Thermoplastic
materials,
thermosensitive
hydrogels



Ultra-High-Temperature (UHT) Printhead

Temperature control:
30°C – 500°C

Materials:
Thermoplastic
materials,
thermosensitive
hydrogels, PEEK



Inkjet Printhead

Temperature control:
30°C – 70°C

Materials: Low
viscous hydrogels,
cell suspensions,
solutions



2-Component (2K) Printhead

Temperature control:
30°C – 70°C

Materials:
2-component
silicones



Co-Axial (COAX) Printhead

Temperature
control: 2°C – 70°C
(dependent on room
temperature, 0°C
may be reached)

Materials: Hydrogels,
2-component
materials with fast
solidification upon
contact (e.g., sodium
alginate and calcium
chloride)



Photo Curing (UV) Printhead

Temperature control: fixed
at 25°C

Materials: None. Head does
not contain a material
chamber, only a light
source

Wavelengths: 365nm,
385nm, 395nm, 405nm,
455nm

Brightness per wavelength:
~150mW/cm²



Material Freedom

The 3D-Bioplotter is an open-materials bioprinting system that also enables easy printing of many materials in one build

The 3D-Bioplotter™ uses a 3D CAD model to define the outer form of a 3D object. After that, users have incredible flexibility to design complex inner patterns for multi-part projects in a wide range of materials. These have one single requirement: solidification.

Our open-materials system can use commercial, technical, research, or

medical-grade materials, including those laden with cells. Users can choose their preferred vendors, or develop their own mixture compositions, concentrations, and additives.

To save time, we also offer our own ready-to-print materials, with complete instructions for printing, pre- and post-processing, and sterilization.

DESKTOP HEALTH 3D-BIOPLOTTER MATERIALS		GRADE
<i>Bone and Cartilage Materials</i>		
LT Hydroxyapatite RG	Hydroxyapatite, self-settling	Research
HT PCL 50K RG	Polycaprolactone, MW 45 kDA	Research
HT PCL 80K MG	Polycaprolactone, MW 80 kDA	Medical
HT PCL 120K MG	Polycaprolactone, MW 120 kDA	Medical
<i>Soft Tissue Materials</i>		
UV Silicone 60A MG	Silicone, short term only, 365nm	Medical
LT Tissuelnk RG	Gelatin-based hydrogel mixture for cell printing	Research
2K Silicone 50A RG	Silicone, 2 component, heat post-cured	Research
<i>Support Materials</i>		
HT Support RG	Sugar-based	Research
LT Support RG	Cellulose-based	Research
LT Silicone TG	Silicone, RTV1	Technical

All materials are delivered with processing parameters and instructions of use. G = technical grade, for example: models; RG = research grade, for example: animal testing; MG = medical grade, USP class VI or similar material intended for human use (restrictions may apply)



PRINT A WIDE RANGE OF MATERIAL TYPES



WATER-SOLUBLE SUPPORT MATERIAL

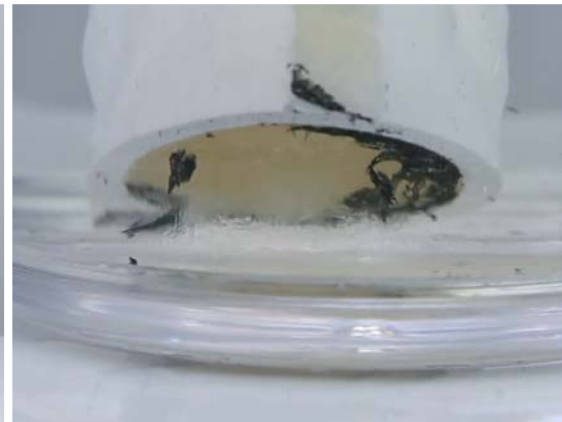

Accessories & Upgrades

Our newest accessory is PrintRoll™ — a rotating build platform that enables 3D printing of cylindrical devices to strengthen the miles of pathways that support the respiratory, vascular, nervous, digestive, reproductive, and other systems

The human body is home to thousands of miles of tubes. Blood vessels alone — arteries, veins, and capillaries — make up more than 60,000 miles. When you consider all of your body's critical operating systems and senses, such as hearing (made possible as sound travels through tiny, hollow ear canals) it's clear that cylindrical devices have an important place in biological design and medicine.

In development since 2019, the 3D-Bioplotter PrintRoll has been a collaboration with Johannes Gutenberg University Mainz, a public research university in Mainz, Germany, and it's a first-of-its-kind solution — a rotating

mandrel with exchangeable drums — for a common desire to develop solutions for tubular body channels.

Until now, biomedical and tissue engineers have been limited to 3D printing potential solutions on flat platforms and then rolling and fixing them into cylinders after printing. Or, attempting to print long tubes vertically with complex support structures that must be removed.

Now, the PrintRoll will enable 3D printing of cylindrical scaffolds on a rotating platform to support vascularization, breathing, digestive systems, wound dressings, stents, and more. Once the motorized build plate is attached to the

build platform with four screws and connected to the machine, users can begin printing directly onto the rotating drum at rotation and print speeds they can define, using all modular printheads.

With multiple user-editable software options available and a visual preview, a multitude of scaffold structures can be printed. The system comes complete with settings for creating various sizes of honeycomb and crisscross designs.

The PrintRoll is compatible with the 4th Generation 3D-Bioplotter Developer and Manufacturer models; machines sold before 2019 may require an update on-site.

The PrintRoll comes standard with a 10 mm rotating drum accessory. Other sizes and custom sizes are available, for easy swap out. Shown here are a 10 mm drum, top left, a 20 mm drum, top right, and a 40 mm drum, bottom left and right with different print designs in polycaprolactone (PCL).



Consumables & Accessories

Desktop Health offers commonly used consumables and accessories to enable the successful use of the 3D-Bioplotter:

- Needle Tips 0.1 mm – 1.2 mm
- Cartridges 3 ml – 30 ml
- Printing Substrates
- Flat Petri Dishes

- Air Compressor
Max Pressure: 7 bar (100 psi)
Oil-free, built-in 5 L tank
Silent, max 56 dBA 23 x 44 x 39 cm, 20 kg
110 / 230 V variants available

- Pressure Booster, doubles input pressure, no electricity required
Max Pressure: 10 bar (150 psi)
Built-in 3 L tank 37 x 34 x 36 cm, 10 kg

- Biosafety Cabinet, shown right, to allow 3D-Bioplotter to work in clean environments
Class II, Type A2
Outer: 164 x 260 x 119 cm (64.5 x 102.4 x 46.9 in)
Inner: 149 x 100 x 100 cm (58.7 x 39.3 x 39.3 in)
110 / 230V variants available

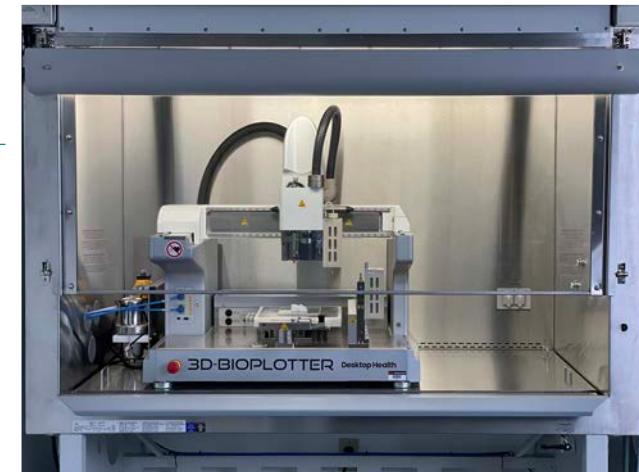

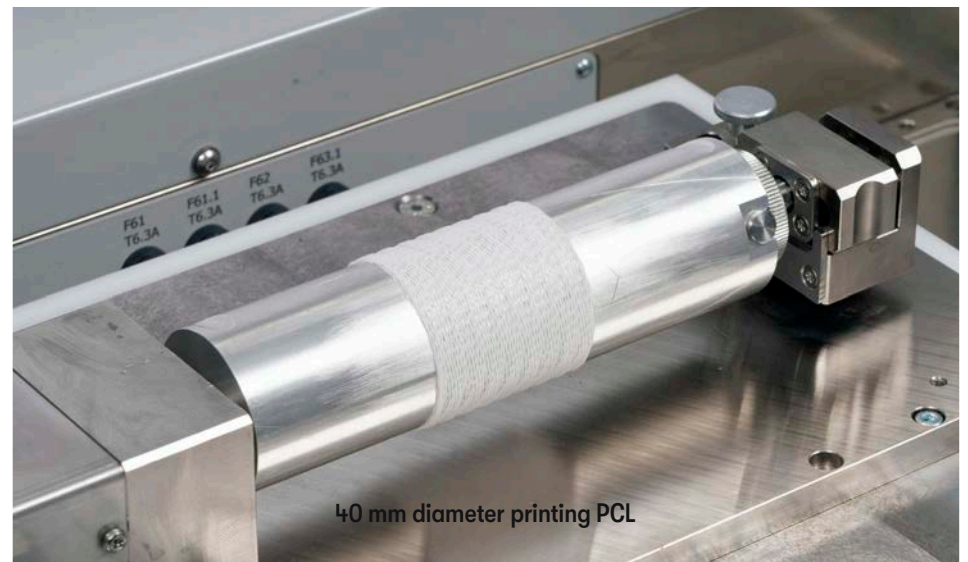
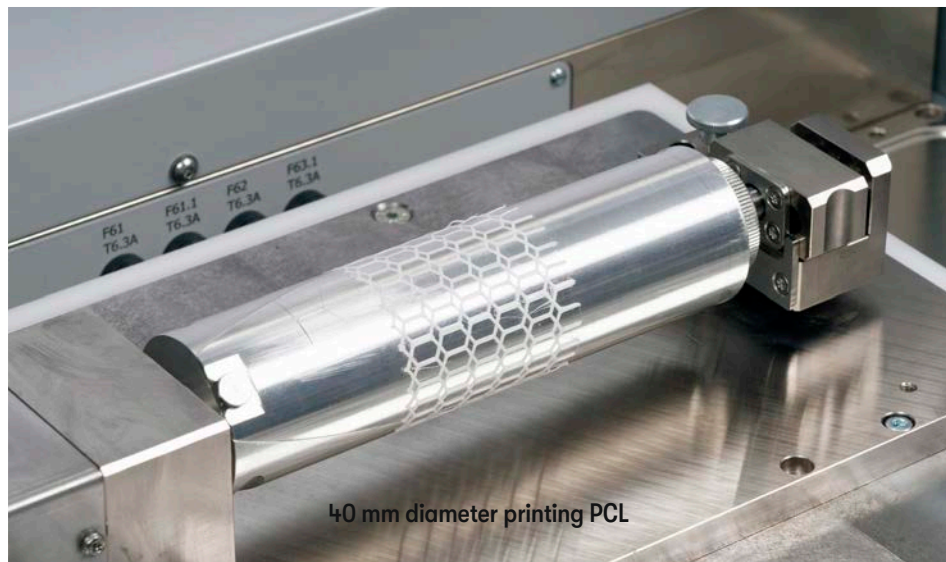
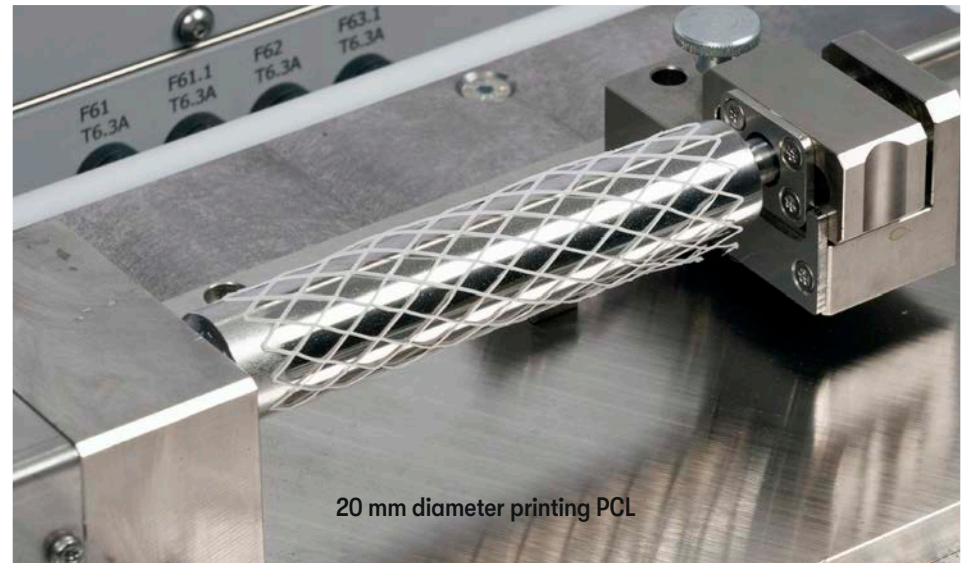

Applications R&D to Commercial

More than 600 scientific, technical, and medical papers have been published in peer-reviewed journals with R&D done on the 3D-Bioplotter, with thousands of citations

The 3D-Bioplotter has been a critical tool for researchers for more than two decades now. While more than a third of all papers have focused on bone regeneration topics, the diversity of medical research done with the system is impressive. Because the 3D-Bioplotter is one of the world's most sophisticated extrusion machines, a significant amount of R&D has also been conducted on the system for non-medical purposes as well.

In 2016, we launched an online database to track the growing amount of research being done with our bioprinter at universities, colleges, hospitals, and companies worldwide. The database, which enables searching by keyword, can be viewed at TeamDM.com/DH3DBioplotter

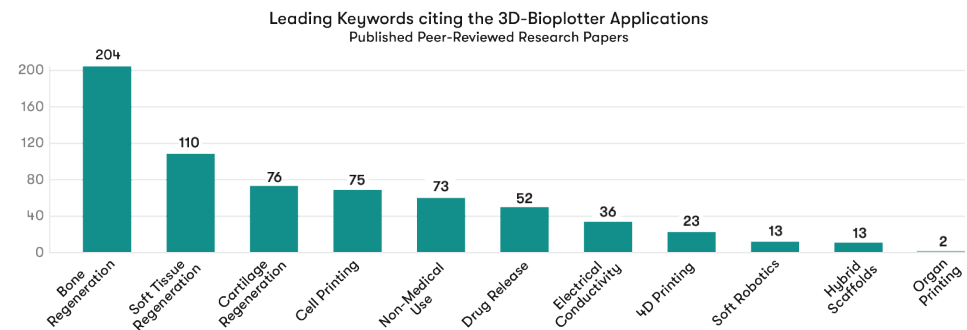

BONE REGENERATION

- Haberstroh, Kathrin, et al. "Bone repair by cell-seeded 3D-bioprinted composite scaffolds made of collagen treated tricalciumphosphate or tricalciumphosphate-chitosan-collagen hydrogel or PLGA in ovine critical-sized calvarial defects." *Journal of Biomedical Materials Research Part B: Applied Biomaterials* 93.2 (2010): 520-530.
- He, Meiling, et al. "3D-Printing Biodegradable PU/PAAM/Gel Hydrogel Scaffold with High Flexibility and Self-Adaptability to Irregular Defects for Nonload-Bearing Bone Regeneration." *Bioconjugate Chemistry* 32.8 (2021): 1915-1925.
- Lee, Chang H., et al. "Regeneration of the articular surface of the rabbit synovial joint by cell homing: a proof of concept study." *The Lancet* 376.9739 (2010): 440-448.
- Zhao, Menglu, et al. "3D-printed strong hybrid materials with low shrinkage for dental restoration." *Composites Science and Technology* 213 (2021): 108902.
- Jakus, Adam E., et al. "Hyperelastic "bone": A highly versatile, growth factor-free, osteoregenerative, scalable, and surgically friendly biomaterial." *Science translational medicine* 8.358 (2016): 358ra127-358ra127.
- Amorosa, L. F., et al. "Physiologic load-bearing characteristics of autografts, allografts, and polymer-based scaffolds in a critical sized segmental defect of long bone: an experimental study." *International Journal of Nanomedicine* (2013): 1637-1643.
- Anderson, Margaret, et al. "Three-dimensional printing of clinical scale and personalized calcium phosphate scaffolds for alveolar bone reconstruction." *Dental Materials* 38.3 (2022): 529-539.
- Xu, Kaifeng, et al. "Mesoporous calcium silicate and titanium composite scaffolds via 3D-printing for improved properties in bone repair." *Ceramics International* 47:13 (2021): 18905-18912.
- Ji, Shen, et al. "3D printed wavy scaffolds enhance mesenchymal stem cell osteogenesis." *Micromachines* 11.1 (2019): 31

RESEARCH HIGHLIGHTS

Craniomaxillofacial, musculoskeletal, dental, PLGA, PLLA, PCL, PU, Bioactive Glass, Hydroxyapatite, Tricalcium Phosphate, Zirconia, Titanium

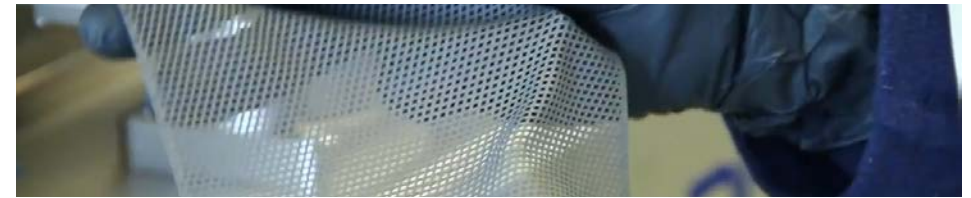
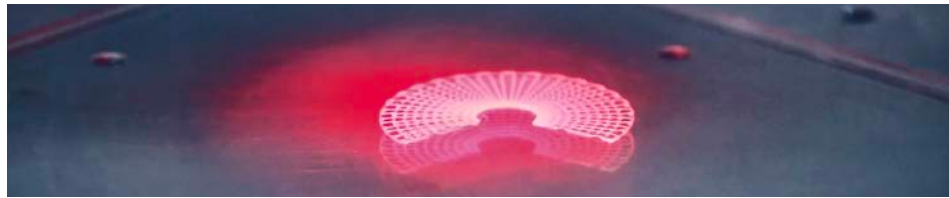

SOFT TISSUE PRINTING

■ Billiet, Thomas, et al. "The 3D printing of gelatin methacrylamide cell-laden tissue-engineered constructs with high cell viability." *Biomaterials* 35.1 (2014): 49-62.

■ Lobo, David Angelats, and Paola

Ginestra. "Cell bioprinting: The 3D-Bioplotter™ case." *Materials* 12.23 (2019).

■ Izadifar, Zohreh, et al. "Analyzing biological performance of 3D-printed, cell-impregnated hybrid constructs for cartilage tissue engineering." *Tissue Engineering Part C: Methods* 22.3 (2016): 173-188.

■ Chang, Jae Won, et al. "Tissue-engineered tracheal reconstruction using three-dimensionally printed artificial tracheal graft: preliminary report." *Artificial organs* 38.6 (2014): E95-E105.

■ An, Geng, et al. "Functional reconstruction of injured corpus cavernosa using 3D-printed hydrogel scaffolds seeded with HIF-1 α -expressing stem cells." *Nature Communications* 11.1 (2020): 2687.

■ Laronda, Monica M., et al. "A bioprosthetic ovary created using 3D printed microporous scaffolds restores ovarian function in sterilized mice." *Nature communications* 8.1 (2017): 15261.

■ Jiang, Xiping, et al. "3D printing of multilayered scaffolds for rotator cuff tendon regeneration." *Bioactive materials* 5.3 (2020): 636-643.

■ Bejleri, Donald, et al. "A bioprinted cardiac patch composed of cardiac-specific extracellular matrix and progenitor cells for heart repair." *Advanced healthcare materials* 7.23 (2018): 1800672.

■ Chung, Johnson HY, et al. "3D hybrid printing platform for auricular cartilage reconstruction." *Biomedical Physics & Engineering Express* 6.3 (2020): 035003.

■ Nachlas, Aline LY, et al. "A multilayered valve leaflet promotes cell-laden collagen type I production and aortic valve hemodynamics." *Biomaterials* 240 (2020): 119838.

RESEARCH HIGHLIGHTS

Cartilage, bioprinting, trachea, heart valve, organ printing, vascularization, alginate, gelatin, GelMA, hyaluronic acid, collagen, bioink, FRESH

DRUG RELEASE

■ Alayoubi, Alaadin, et al. "Mechanistic understanding of the performance of personalized 3D-printed cardiovascular polypills: A case study of patient-centered therapy." *International Journal of Pharmaceutics* 617 (2022): 121599.

■ El Aita, Ilias, et al. Jörg Breitreutz, and Julian Quodbach. "Investigation of semi-solid formulations for 3D printing of drugs after prolonged storage to mimic real-life applications." *European Journal of Pharmaceutical Sciences* 146 (2020): 105266.

■ Zhang, Jianhua, et al. "3D-printed magnetic Fe₃O₄/MBG/PCL composite scaffolds with multifunctionality of bone regeneration, local anticancer drug delivery and hyperthermia." *Journal of materials chemistry B* 2.43 (2014): 7583-7595.

■ Fu, Shengyang, et al. "Silicone resin derived Iarnite/C scaffolds via 3D printing for potential tumor therapy and bone regeneration." *Chemical Engineering Journal* 382 (2020): 122928.

RESEARCH HIGHLIGHTS

Tablets, growth factors, tumor therapy, models, 4D printing, electrical conduction, thermal storage, construction, food printing, PDMS, graphene

OTHER

■ Neufeld, Lena, et al. "Microengineered perfusable 3D-bioprinted glioblastoma model for in vivo mimicry of tumor microenvironment." *Science advances* 7.34 (2021): eabi9119.

■ Jakus, Adam E., et al. "Three-dimensional printing of high-content graphene scaffolds for electronic and biomedical applications." *ACS nano* 9.4 (2015): 4636-4648.

■ Zolfagharian, Ali, et al. "Pattern-driven 4D printing." *Sensors and Actuators A: Physical* 274 (2018): 231-243.

■ Stolz, Benjamin, and Rolf Mülhaupt. "Cellular, mineralized, and programmable cellulose composites fabricated by 3D printing of aqueous pastes derived from paper wastes and microfibrillated cellulose." *Macromolecular Materials and Engineering* 305.4 (2020): 1900740.

■ Kouzani, Abbas Z., et al. "3D printing of food for people with swallowing difficulties." *KnE Engineering* 2.2 (2017): 23-29.

FDA Cleared: CMFlex™

Born out of Northwestern University, Chicago-based Dimension Inx has received U.S. Food and Drug Administration 510(k) clearance for CMFlex™ – the first 3D-printed regenerative bone graft product cleared by the FDA and the first such clearance based on manufacturing on the 3D-Bioplotter

The journey from R&D to FDA clearance of CMFlex, a ready-to-use flexible ceramic for oral and maxillofacial indications, started in 2009 for two of the co-founders of Chicago-based Dimension Inx: Ramille Shah, Ph.D., Head of R&D, and Chief Science Officer, and Adam Jakus, Ph.D., Head of Technology Strategy and Chief Technology Officer.

CMFlex aims to improve clinical outcomes for patients who require a bone graft to correct a disease, injury, or defect of the face, jaw, or mouth. CMFlex provides an alternative to an intrusive and sometimes painful process – called an autograft – where doctors harvest or take bone from another area of a patient's body to form it into the shape of the desired anatomy where a bone graft is needed.

The unique properties of CMFlex allow it to be easily cut and trimmed to the desired size and shape, while maintaining structural integrity. Once implanted, the body's natural healing process begins. CMFlex serves as a scaffold or framework for new bone tissue to grow and regenerate. Over time, cells from the surrounding area migrate into the graft and gradually begin to fill in the spaces within the scaffold, allowing it to become a permanent part of the patient's body.

In addition to her role at Dimension Inx, Shah is a tenured Associate Professor in Biomedical Engineering at the University of Illinois at Chicago. Shah earned her B.S. in Materials Science and Engineering (MSE) at Northwestern University and



her Ph.D. in MSE with a specialty in Biomaterials from the Massachusetts Institute of Technology.

Shah's R&D laboratory at Northwestern University was an early adopter of the 3D-Bioplotter technology that led to CMFlex. Early on, she recognized that the bioprinting system could create complex, reproducible structures that mimic the body's own architectures with porous structures and highly controlled material properties. This might enable the body to interact in desirable ways with these 3D printed devices and help guide repair and healing. "I was really interested in

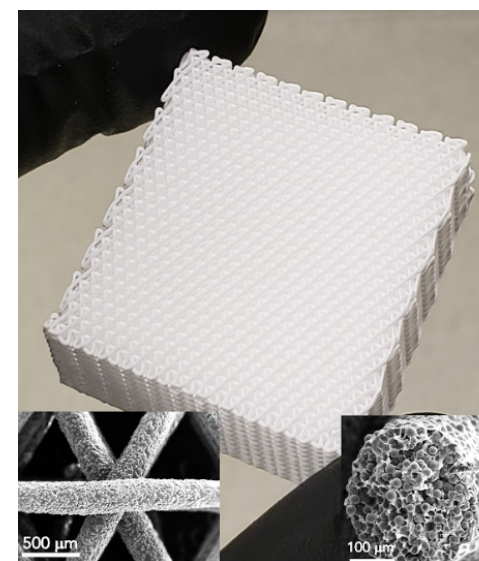

TOP LEFT, OPPOSITE PAGE: Adam Jakus, Ph.D., Co-founder, Head of Technology Strategy, and Chief Technology Officer, and Ramille Shah, Co-Founder, Head of R&D, and Chief Scientific Officer at Dimension Inx, have been pioneers in leveraging the 3D-Bioplotter Manufacturer series to develop and now commercialize 3D-printed regenerative medical devices.

BOTTOM LEFT, OPPOSITE PAGE: CMFlex™, shown here, has an intentionally engineered three-dimensional architecture with macro, micro, and nano-level features designed to promote bone regeneration after implantation to promote healing.

RIGHT: Ramille Shah working in the lab on Hyperelastic Bone®, a flexible regenerative bone material that laid the R&D foundation for CMFlex™, which recently received FDA 510(k) clearance.



Photo courtesy of the National Science Foundation.

how scaffold architecture plays a role in the biological response," Shah recalled.

Shah and Jakus together embarked on research in a variety of areas over the years with the 3D-Bioplotter, including bioprosthetic organs — the work on a bioprosthetic mouse ovary that resulted in a live birth was theirs. But it was their work on a new family of engineered 3D-printable biomaterials, particularly the mechanically resilient Hyperelastic Bone® that received a tremendous amount of attention and seemed to have true market demand.

"It was in Science Translational

Medicine and it received a lot of press," Shah recalled.

Ultimately, Hyperelastic Bone served as the foundation for CMFlex, which is manufactured on the 3D-Bioplotter. "In order to make an impact, we needed to have actual products come out," she said.

After years of hard work, Dimension Inx is now readying CMFlex for commercial deployment. "It's an emotional moment because now we have the opportunity to actually get it into patients," Shah said.

While there are other competing ceramic bone graft products on

the market, Shah said the 3D printed product is surgeon-friendly and flexible, made up largely of hydroxyapatite, which is the main mineral component in bone, and a small amount of poly(lactic-co-glycolic acid).

"What makes ours different," Shah and Jakus explained, "is that we have a micro- and macroporous structure made of the mineral that's natural in bone, but is also user friendly and permits excellent tissue integration and growth."

Shah said the 3D-Bioplotter was a critical tool and partner in the endeavor to develop and

commercialize CMFlex. "We looked at other platforms," Shah said, but 3D-Bioplotter stood above the others for a variety of reasons:

- **Multimaterial capabilities.** The ability to manufacture easily with multiple components and designs in one space with ease. "Multi-material capabilities was a big plus for me because when you think about trying to create multi-tissue constructs or even organs, you need to be able to deposit different materials, different cells in a 3D space."

- **High print speeds.** Shah said the 3D-Bioplotter prints the materials quickly, with good acceleration and deposition control

- **Easy-to-use software.** "It's so easy to use and it let us do what we needed to," Shah said.

- **Reliable hardware.** Shah's team wanted to focus on the materials, not the hardware or software

"The 3D-Bioplotter has been consistently reliable, as the hardware is well-built and handles both small and large, slow and fast, builds consistently," Jakus said. "Beyond the hardware, the software really shines, allowing for rapid pore architecture design and application to object files without the need for extensive, time consuming CAD activities to implement small or large changes."

Desktop Health

The healthcare brand of Desktop Metal, Desktop Health™ delivers 3D printing technology trusted for 20+ years to improve patient lives

Our high-accuracy 3D printers, paired with premium biocompatible materials, have been proven to deliver reliable, regulatory-approved dental and medical solutions. Desktop Health is rooted in the history of EnvisionTEC, which was acquired by Desktop Metal in 2021.



See how our Flexcera™ material is changing lives

Watch Ray Philon's journey to reclaim his smile, which has transformed his life forever.



Before

After



Meet Beth

She used to hide her smile, but since receiving Flexcera Smile, "I just let 'em flash. ... I haven't stopped smiling."



Meet Maria

An avid runner, she now loves to take selfies on the trail to show off her beautiful Flexcera Smile to everyone.



Meet Patty

After receiving her Flexcera Smile transformation, Patty said: "I smile in the car just driving all by myself – I love it."



Meet Debbie

Debbie appreciates how she can now eat what she wants thanks to the function and fit of her beautiful Flexcera Smile.

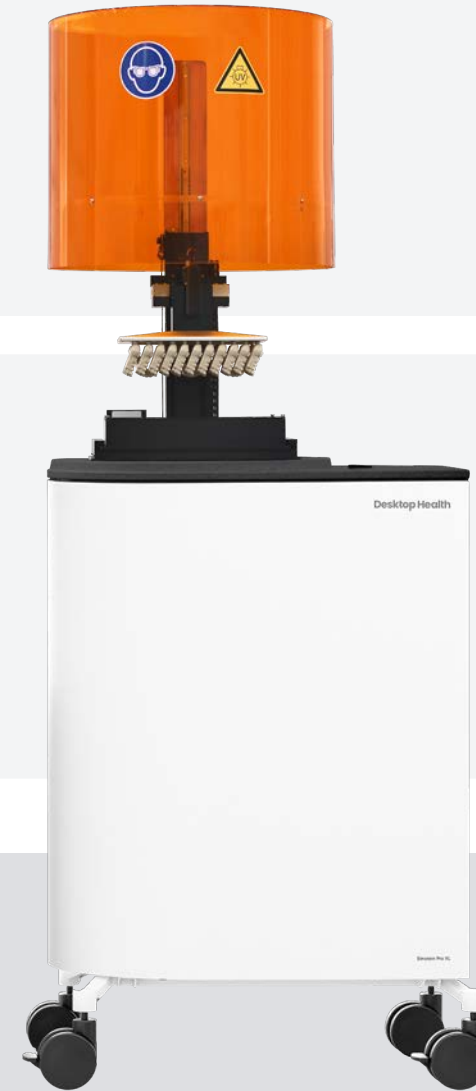
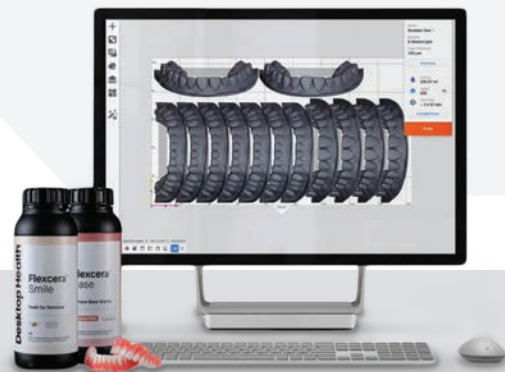

Einstein™ + Flexcera™

The Einstein family of DLP dental printers includes a desktop printer for speed and the larger Pro XL for high throughput. Both systems deliver exceptional accuracy with our DLP technology.

Equipped with Hyperprint™ technology to harness the power of heat, closed-loop sensors, and software, the Einstein is a reliable, affordable, and fast tool that's easy to use. What's more, the Einstein

prints the proven Flexcera family of dental materials, which includes Flexcera Base, Smile, and Smile Ultra+, a set of ceramic-strong materials that have high fracture resistance, a beautiful aesthetic,

and precision fit. With the Einstein and Flexcera, dental providers can now print crowns, bridges, veneers, inlays/onlays, and full and partial dentures with an easy-to-use workflow.

PhonoGraft® Biomimetic Hearing Restoration

Printed on the 3D-Bioplotter, this novel device is on a path toward FDA 510(k) clearance and commercialization

Born from six years of research and development, the PhonoGraft is a 3D-printed biocompatible graft that can permanently repair eardrum perforations in patients with a minimally invasive solution.

Current eardrum grafts do not degrade or regenerate the eardrum's native structure, which can lead to poor healing and hearing outcomes, and revision surgeries. To solve these challenges, the PhonoGraft device uses novel materials printed on the 3D-Bioplotter that mimic the circular and radial microstructure of the eardrum's tympanic membrane, encouraging cells to regenerate tissue along the print path leaving behind tissue while the device slowly degrades.

Nicole Black, PhD, VP of Biomaterials and Innovation for Desktop Health™, was a co-inventor of the device as part of a multidisciplinary team at Harvard's Wyss Institute, where Black worked as a graduate student in Prof. Jennifer Lewis' Lab. Other collaborators included the Harvard John A. Paulson School of Engineering and Applied Sciences (SEAS), and Massachusetts Eye and Ear (MEE)/Mass General Brigham (MGB). Black eventually co-founded Beacon Bio to commercialize the project, and the company was acquired by Desktop Metal in 2021. "The tympanic membrane, commonly known as the eardrum, serves an important role in sound conduction," Black explained. "Although it is a thin tissue, the eardrum contains a layer of circularly and radially aligned collagen fibers that



Nicole Black, PhD, VP of Biomaterials and Innovation for Desktop Health™, was part of a team that cofounded the PhonoGraft project. Right, the PhonoGraft being manufactured in serial production, along with a closeup of the radial device.

enable it to vibrate well across a wide range of frequencies. Current graft materials used to repair the eardrum are imperfect, as these materials do not degrade or remodel into the native structure of the eardrum. This can lead to poor healing outcomes, poor hearing outcomes, and revision surgeries for patients."

Additionally, the team is working on innovative design strategies to enable placement of the PhonoGraft device through the ear canal in an awake patient, hopefully eliminating the need

for general anesthesia during eardrum repair procedures.

The reason Black chose the 3D-Bioplotter to develop and commercialize the PhonoGraft device is because she found it "absolutely unmatched" in hardware, software, and commercialization capabilities. While the high precision and reliable repeatability were critical, she said there were numerous reasons the system has been an essential tool:

■ **Empowering Hardware** – The Manufacturer Series has five parking



positions for multiple material printing with seven different printhead types, offering a wide temperature range with micron precision.

■ **User-Friendly Software** – The software system is intuitive and easy to use, allowing Black's team to focus on the end-goal and “truly recapitulate these complex features and functionality.”

■ **FDA Ready** – The overhead built-in camera is adjacent to the printhead and enables medical device traceability that allows the team to prove batches were consistently

manufactured, while log files generated during the job assist in quality control.

The team has had incredible success in animal testing the PhonoGraft device. Desktop Health anticipates having 510(k) clearance by the end of 2025. If clinically successful, the PhonoGraft technology could provide a less invasive approach to mitigate the pain, drainage, and hearing loss associated with eardrum perforations that affect millions of individuals worldwide each year.

Eardrum

(tympanic membrane)

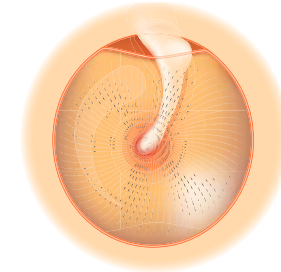

A normal tympanic membrane, left, has a radial structural design that vibrates across a wide range of frequencies to enable hearing.

A ruptured eardrum, right, can lead to hearing loss.

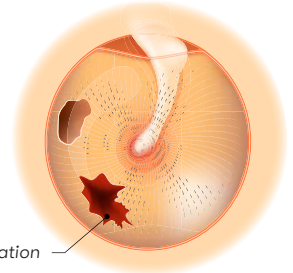

Perforation

The PhonoGraft device, which is serially manufactured on the 3D-Bioplotter, shown above and below left, mimics a normal eardrum. After helping tissue regenerate into the proper structure, it eventually degrades. The device is also designed for easy placement in patients, shown bottom right.

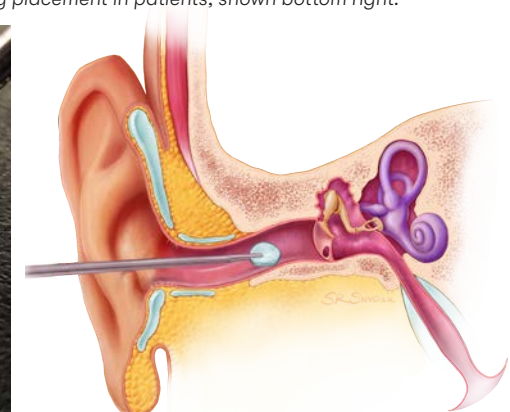
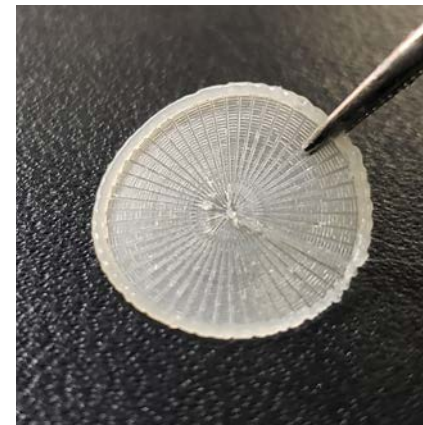
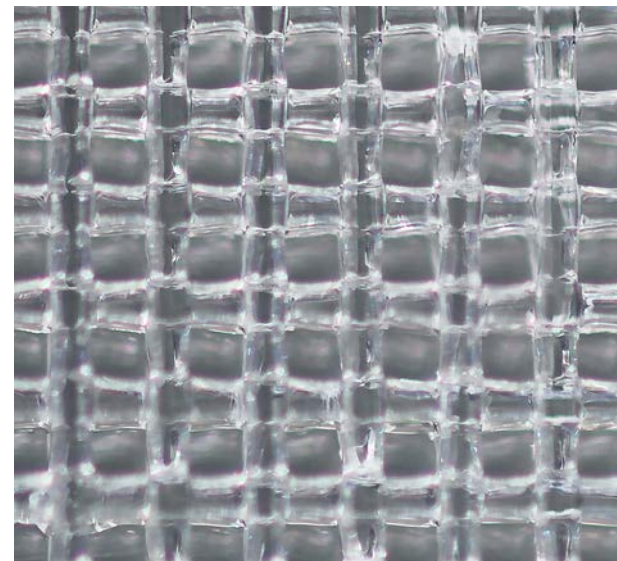
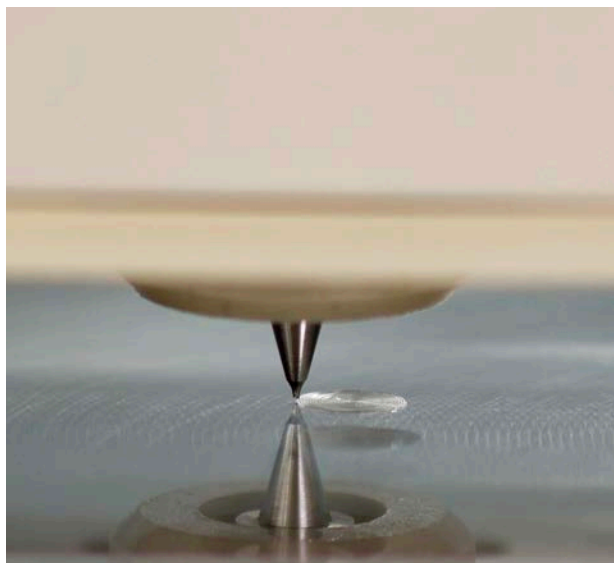
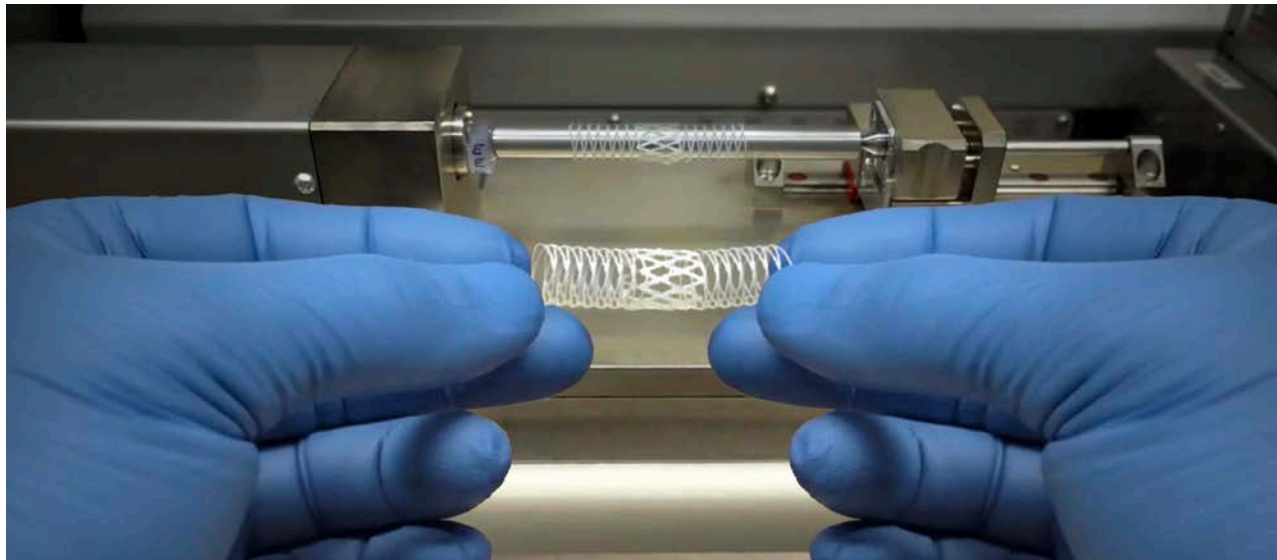

Illustration Credit: Shawna R. Snyder



Pictured far left, the Low Temperature printhead come standard with the 3D-Bioplotter and is used for most materials printed below 40°C. Top center, the 3D-Bioplotter prints the PhonoGraft® eardrum repair device. Lower center, Nicole Black, PhD, VP of Biomaterials and Innovation for Desktop Health™, inspects a PhonoGraft device. Top right, a student at Minuteman High School in Lexington, Mass., working on a 3D-Bioplotter. Lower right, a closeup of a hydrogel scaffold.



Pictured top left, biopatterning a matrix of 20 by 20 dots with cells on the center of a petri dish for material biocompatibility studies or early stage drug testing. Top right, a firm, 3D printed silicone jaw "bone." Lower left, a cylindrical scaffold printed on the new PrintRoll™ rotating build platform at Johannes Gutenberg University Mainz in Germany. Zayna Alhuseini, PhD, Director of Quality and Operations at DH-BIO, holds a model of ear pinnae for surgical modeling printed in silicone with the UV Print-and-Cure printhead.

Desktop Health

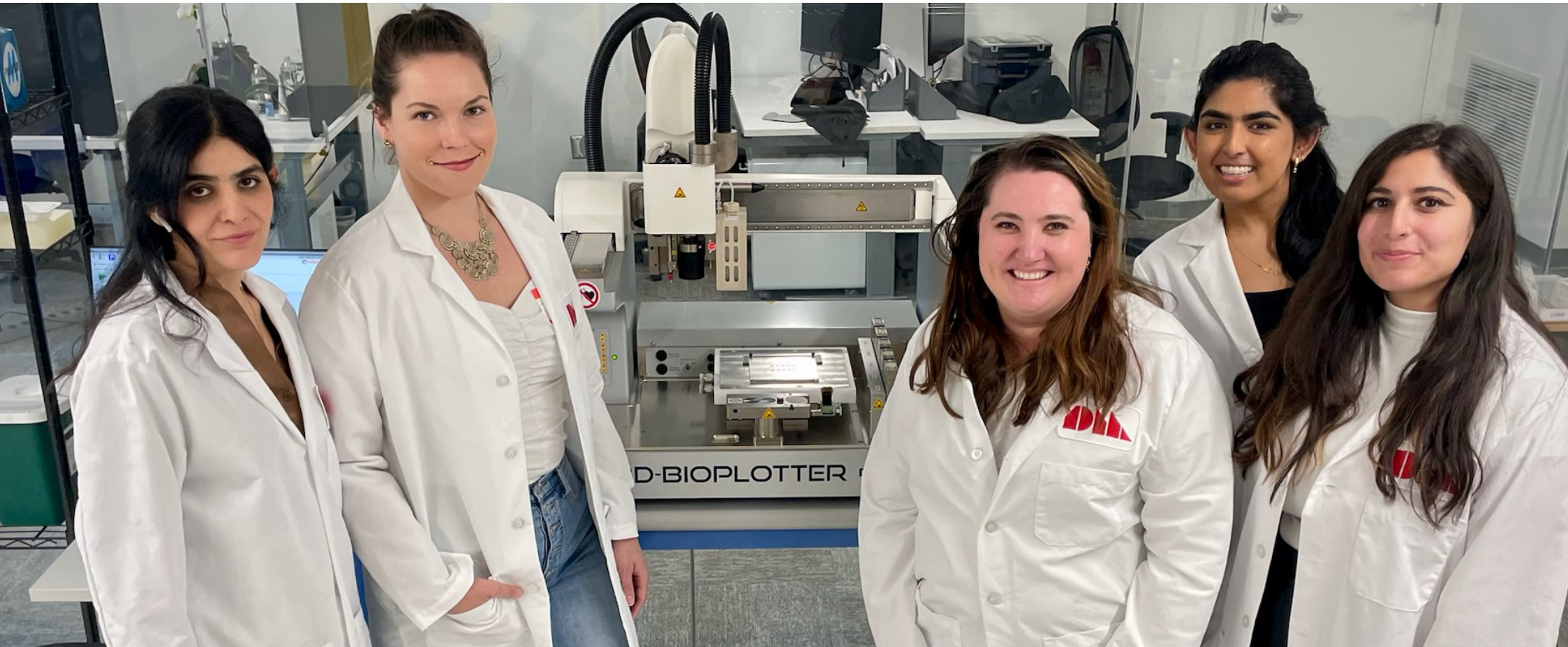

Desktop Health is the trusted health brand of Desktop Metal (NYSE:DM). DM is driving Additive Manufacturing 2.0, a new era of on-demand, digital mass production of industrial, medical, and consumer products.
Learn more at TeamDM.com/health



Desktop Health
63 3rd Ave., Burlington, Mass.
1-866-344-3578
#TeamDM | NYSE:DM

© 2023 Desktop Metal, Inc. All rights reserved